

Standard Pump

SP-8850 & SP-8950



Description

Standard's Drum Pumps are designed to transfer a variety of materials from 55 gallon (200 l) drums and tanks. Standard Pump offers several different pumps, each designed for specific applications. Before operating, please confirm that the pump's materials of construction are suitable for the application.

Unpacking

Cartons should be handled with care to avoid damage from dropping, etc. After unpacking, inspect carefully for any damage that may have occurred during transit. Check for loose, damaged or missing parts.

General Safety Information

The responsibility for safe assembly, installation, and operation ultimately rests with the operator. Read and understand ALL safety precautions and operating instructions before operation. Careless pump operation can result in serious injury.

1. Before operating the pump, read and understand these operating instructions.
2. The operator should wear suitable protective clothing including the following: face mask, safety shield or goggles, gloves, apron, and safety shoes.
3. Before operating, verify the materials being pumped are compatible with the pump's "wetted components."

4. All Federal, State, and local safety codes should be followed.
5. Verify that the motor voltage corresponds to proper electrical supply. Before plugging motor into power supply, make sure the motor switch is in the OFF position. For Air Motors ensure inlet valve is closed before attaching air line.
6. Before operation, confirm all pump connections are properly tightened.
7. First pump clean water in order to familiarize yourself with the pump's operation, flow rate, discharge pressure and motor speed.
8. Before starting the pump, confirm the discharge hose is securely fastened to the receiving vessel in order to prevent splashing.
9. Never leave pump unattended during operation.
10. Do not submerge the motor in any liquid.
11. When finished using the pump, flush the pump by pumping water or an appropriate cleaning solution. Do not use flammable or combustible cleaning solutions.
12. Never carry the motor by the power cord.

Assembly

1. Remove the pump and motor from packaging.
2. Inspect all contents for damage.
3. Couple the motor to the pump tube by using the Connection Nut (see Figure 1).

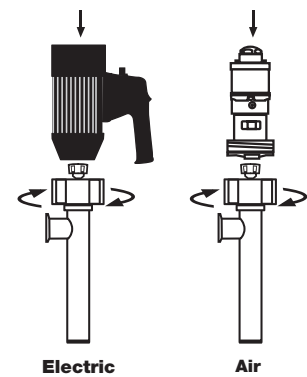

Figure 1

4. It is recommended to thoroughly clean and sanitize models SP-8850 & SP-8950 before operation.

SP-8850 & SP-8950 Specifications

Model	Immersion Length	Wetted Components	Motors Drive	Discharge Size	Max Viscosity	Max Discharge Pressure	Max Flow Rate	Max Temp	Pump Weight
SP-8850	39" (1000 mm) Drums 47" (1200 mm) Tote®Tanks & Kettles	SS316L, PTFE & Buna	SP-ENC, SP-A1, SP-A2, SP-400 Series	1 1/2" Tri-Clamp®	1,000 cps (mPAS)*	11 psi (0,75 bar)	31 GPM (117 LPM)	175° F (80° C)	11 lbs (5 kg)
SP-8950	39" (1000 mm) Drums 47" (1200 mm) Tote®Tanks & Kettles	SS316L, PTFE & Buna	SP-ENC, SP-A1, SP-A2, SP-400 Series	1 1/2" Tri-Clamp®	1,000 cps (mPAS)*	21 psi (1,4 bar)	21 GPM (79 LPM)	175° F (80° C)	11 lbs (5 kg)

Note: Flow rates are based on water. As viscosity increases, the flow rate will decrease.

Note: Pump is constructed with FDA compliant materials; however, the pump does not have FDA certification.

*Pump is intended for intermittent use when operating at maximum viscosity.

SP-8850 & SP-8950

⚠ WARNING *Do not use these pumps for the transfer of flammable or combustible products or in an environment where flammable or combustible fumes are present unless used in conjunction with an Explosion Proof Motor, SP-A1 or SP-A2 Series air motor. Please contact the factory or authorized distributor with any questions regarding this matter.*

General Operation Guide

1. Use a closed top drum or other cover to prevent possible contamination.
2. Once the pump is fully cleaned, assembled and all connections are securely fastened, insert the pump into the drum or tank.
3. It is recommended to attach a suitable hose or pipe to the pump discharge (see Figure 12).

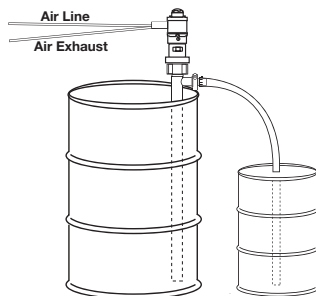

Figure 12

Note: It is recommended to plumb the SP-A1 and SP-A2 exhaust air away from drum or tank to avoid possible contamination. Left port is air intake, right port is air exhaust.

4. If you opt to use a hose, fasten the hose to the hose barb with a suitable hose clamp that exceeds the pump discharge pressure.

⚠ WARNING *Make sure the hose meets the pump discharge pressure requirements (SP-8800 = 16 psi (1,1 bar) / (SP-8900 = 32 psi (2,2 bar)). It is recommended to use a hose that is rated 4 x the pump discharge pressure.*

Ex: 32 x 4 = 128 psi (9 bar).

5. Turn the motor to the "ON" position.
6. After use, clean the pump and store vertically.

Disassembly / Cleaning Procedures (SP-8850 & SP-8950)

1. In order to clean a majority of the residue from the pump tube, immerse the pump into a 55 gallon (200 l) drum of water or a non-flammable, food safe cleaning agent. Allow the pump to circulate the water for 3 minutes.
2. For a more thorough cleaning remove the motor from the pump tube by loosening the connection nut (see Figure 13).

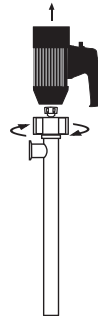

Figure 13

3. Remove the connection nut (see Figure 14)

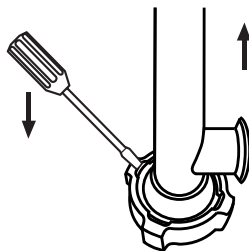

Figure 14

4. Remove Tri-clamp® fitting
5. Pull straight up separating the inner tube assembly from the outer tube assembly (see Figure 15).

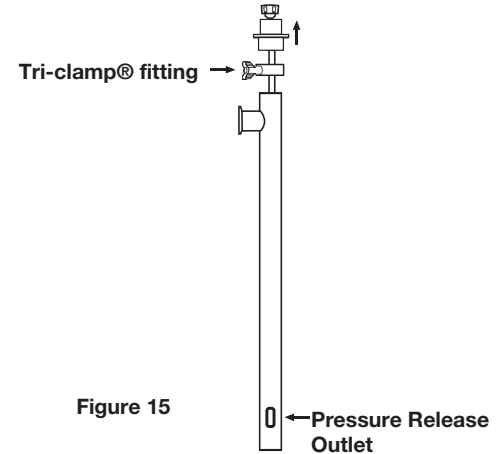

Figure 15

NOTE: During reassembly, ensure that the pressure release holes at the bottom of the outer tube line up with the holes in the pump housing stability wing prior to tightening the tri-clamp fitting.

6. Grasp the pump coupling with one and the impeller the other hand. Rotate the impeller counterclockwise to loosen (see Figure 16).



Figure 16

SP-8850 & SP-8950

Disassembly / Cleaning Procedures (Continued)

7. Remove O-ring below pump housing stability wing (see Figure 17).



Figure 17

8. Grasp pump housing stability wing and pull straight down removing it from the inner tube assembly (see Figure 18).



Figure 18

NOTE: During reassembly, insure that the flat surfaces on the ID of the pump housing stability wing match the flat surfaces on the OD of the inner tube assembly.

9. Remove O-ring from drive shaft located behind impeller (see Figure 19).

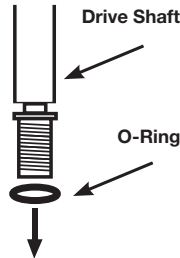

Figure 19

10. Secure inner tube assembly. Lightly tap drive shaft up through inner tube assembly (see Figure 20).

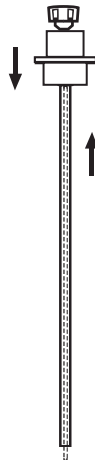

Figure 20

11. Remove guide sleeve from drive shaft (see Figure 21).



Figure 21

12. Remove coupling, bearings, bearing spacer, and secondary seal from drive shaft (see Figure 22).

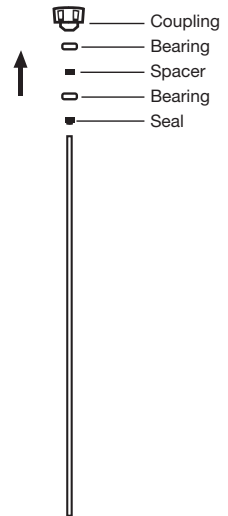

Figure 22

13. Use a non-flammable, food safe cleaning agent to manually clean remainder of pump tube.

14. After thoroughly inspecting all components, reassemble in the reverse order of disassembly steps. Make sure all components are clean, secure and undamaged.

SP-8850 & SP-8950

SP-8850 & SP-8950 Spare Parts List

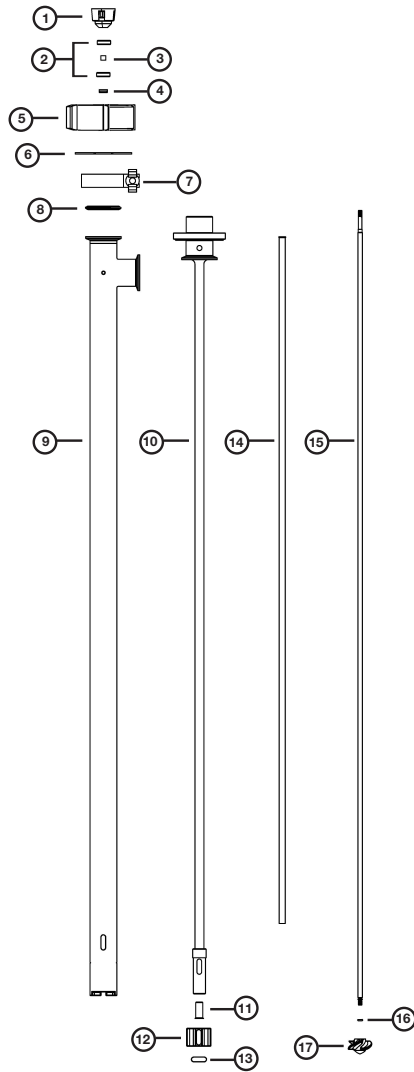

Reference Number	Description	Part Number for Model SP-8850	Part Number for Model SP-8950	Qty
1	Pump Coupling, Nylon	1004	1004	1
2	Bearing, Shielded, Food Grade Grease	8838-2	8838-2	1
3	Bearing Spacer, SS316L	8838-4	8838-4	1
4	Secondary Seal, PTFE, SS316L	8803	8803	1
5	Connection Nut, SS316L	8842	8842	1
6	Snap Ring, SS316	8208	8208	1
7	Tri-Clamp, SS316	833	833	1
8	Tri-Clamp Gasket, Buna	836	836	1
9	Outer Tube, SS316L			1
	High Volume, 39" (1000 mm)	8881	-	
	High Volume, 47" (1200 mm)	8882	-	
	High Pressure, 39" (1000 mm)	-	8981	
	High Pressure, 47" (1200 mm)	-	8982	
10	Inner Tube Assembly, SS316L			1
	39" (1000 mm)	8885	8885	
	47" (1200 mm)	8886	8886	
11	Bushing, PTFE	8825	8825	1
12	Pump Housing Stability Wing, PTFE	8895	8895	1
13	O-Ring, Buna	8896	8896	1
14	Guide Sleeve, PTFE	8811	8811	1
15	Drive Shaft, SS316L			1
	39" (1000 mm)	8891	8891	
	47" (1200 mm)	8892	8892	
16	O-Ring, Buna	8830	8830	1
17	Rotor/Impeller, SS316L			1
	High Volume	7706	-	
	High Pressure	-	8928	

Hazardous Duty Operation: SP-8850 & SP-8950

▲ WARNING *When pumping flammable or combustible products or operating in a hazardous duty environment, the SP-8850 & SP-8950 Series pump must be used in conjunction with an explosion proof motor. Please contact the factory or an authorized distributor with any questions regarding this matter.*

SP-420EX, SP-440EX & SP-A1

When operating in Hazardous Duty applications, the SP-420EX, SP-440EX or SP-A1 must be used in conjunction with an SP-8850 or SP-8950 Series pump and properly bonded and grounded. Refer to the Motor specification chart for motor information.

Special Conditions for Safety Use

- Only for conductive liquids (gases groups IIA and IIB).
- The flashpoint for the flammable media shall be 50°C higher than the maximum temperature T4 (135°C).
- The tube shall regular be inspected for damage and corrosions. If there is any damage or corrosions the equipment and the tube shall be taken out of service.
- The grounding clamp and wire on the pump shall be connected to the liquid container before and after pump start.
- The pumps must not be exposed to pumping hard solid particles which can create sparks.
- Demands for inspections, maintenance and repair according to the instructions.
- The pump is only for hand held operation and should not run dry.

Drum Pump Installation **SP-400 Series**

- Install the Pump and Static Protection Kit as described in Figure 22 on page 8.
- Connect Ground Wire assembly to earth ground using supplied clamp.
- Connect Ground Wire between drum and earth ground.
- Connect Ground Wire between receiving container and earth ground (or use bonding wire to connect to drum).

▲ CAUTION *Check electrical continuity of all components before pumping. All should be one (1) ohm or less.*

Operation and Safety Guidelines

- Use only metallic pump tubes with explosion proof motors to transfer flammable or combustible liquids.
- Area for use must comply with NFPA 30 guidelines for safe storage and use of flammable and combustible liquids.
- All containers and other equipment must be metal and grounded.
- Follow NGPA 77 guidelines for control of static electricity.
- Avoid splashing. Splash filling can create static electricity and is extremely hazardous.
- Fluid velocity must be 3 feet/second (0.91 meters/second) maximum 7 GPM in 1" hose (26.5 LPM in 25 mm hose).

Use Of Air Motors In Hazardous Atmospheres

SP-A1 Series & SP-A2 Series

Note: This statement is only applicable in North America.

At the present time, there are no known standards governing the operation of air motors in hazardous atmospheres. However, there are several points regarding the safety of air motors.

First of all, an air motor is not a source of electric sparks. However, it is possible that an article which is not part of the air motor (e.g., wrenches, hammers, etc.) could create a spark by sharply impacting a cast iron or aluminum case or the steel shaft of the air motor. (Note that electric motor enclosures for both class I and II hazardous locations can be made of "...iron, steel, copper, bronze, or aluminum..." (UL 674, Electric Motors and Generators – Hazardous Locations, June 23, 1989; paragraph 4.2, page 6). Second, an air motor housing is not designed to contain an internal explosion as is an explosion-proof electric motor. The only possible internal source of ignition in an air motor is a contact between the station housing components and the rotating elements that might create a spark. The likelihood of this occurring is reduced by the fact that the contact must be made at precisely the same time as a flammable or

explosive gas is introduced into the air motor in a sufficient quantity to achieve a flammable or explosive mixture while overcoming the positive pressure of the driving gas. In other words, although highly improbable, an internal explosion in an air motor is possible. Finally, an air motor is designed to be operated by compressed air, the expansion of which in normal operation creates a cooling effect. As a result, the temperature of the air motor will not exceed the height of the temperatures of the surrounding atmosphere or the air delivered to the inlet.

We do not guarantee the safety of every application, but to ensure the safe operation of an air motor in your application, always follow the product direction and consult with a qualified engineer. (Source: Gast Manufacturing, Air Motors Handbook, page 2).

▲ WARNING *When using an SP-A1 or SP-A2 Series motor, Standard Pump recommends the use of a Filter Lubricator Regulator (FLR) in order to ensure a moisture free supply of air to the motor.*

▲ WARNING *SP-A1 and SP-A2 Series motors must be lubricated daily to ensure proper functionality*

Grounding Procedures

▲ WARNING *Transferring of flammables or use in hazardous duty. Bonding is an electrical connection between a primary metal vessel and a metal receiving vessel. See schematic.*

Grounding is an electrical connection between a metal vessel, pump, motor and a constant ground; i.e. a metal rod driven into the earth.

Bonding and grounding are required when pumping flammable materials or in hazardous duty environments. Failure to bond and ground properly can cause a discharge of static electricity resulting in fire, injury or death. Follow NFPA 77 and 30 procedures at all times. If in doubt, do not start pump! Be sure bonding and grounding wires are secure before starting operation. (Ground and bond wires must have less than one ohm resistance for safe usage. Check continuity before starting). Always check with a safety engineer when any question arises and periodically check safety procedures with a safety engineer (see Figure 10, page 8).

SP-8850 & SP-8950

Grounding Procedures

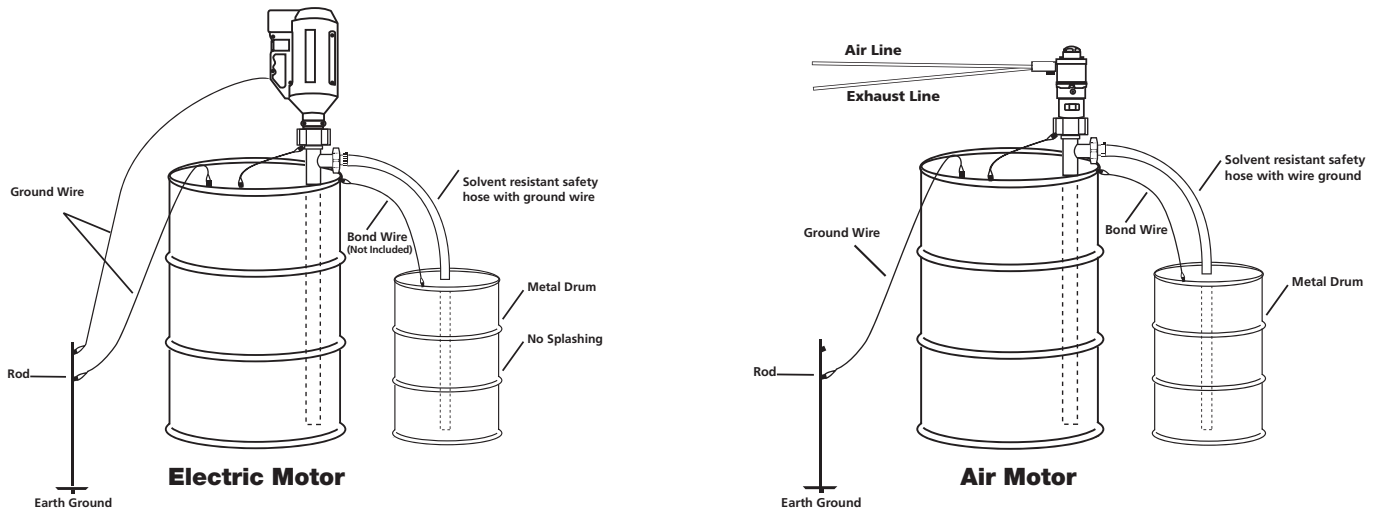

Figure 22 - Static Protection Kit

ISSUE DATE: August 13, 2018

CERTIFICATE AUTHORIZATION NUMBER: 3670



THIS IS TO CERTIFY THAT

Unibloc Hygienic Technologies

1610 Satellite Blvd., Suite D, Duluth, GA 30097

is hereby authorized to continue to apply the
3-A Symbol to the models of equipment, conforming to 3-A Sanitary Standards for:

Number 02-12
02-12 (Centrifugal and Positive Rotary Pumps)

set forth below

SP-850, SP-8850 and SP-8950 Pump Models include:

SP-850SR-751 & SP-850SR-752

SP-850DD-751 & SP-850DD-752

SP-850SR-1851 & SP-850DD-1851

SP-8850-39 & SP-8850-47

SP-8950-39 & SP-8950-47

Pump Model Lengths: 39 and 47 Inch

VALID THROUGH: **December 31, 2023**

Timothy R. Rugh
Executive Director
3-A Sanitary Standards, Inc.

The issuance of this authorization for the use of the 3-A Symbol is based upon the voluntary certification, by the applicant for it, that the equipment listed above complies fully with the 3-A Sanitary Unibloc Hygienic Technologies(s) designated. Legal responsibility for compliance is solely that of the holder of this Certificate of Authorization, and 3-A Sanitary Standards, Inc. does not warrant that the holder of an authorization at all times complies with the provisions of the said 3-A Sanitary Standards. This in no way affects the responsibility of 3-A Sanitary Standards, Inc. to take appropriate action in such cases in which evidence of nonconformance has been established.

NEXT TPV INSPECTION/REPORT DUE: **October 2026**

EU Declaration of Conformity ATEX 2014/34/EU

We herewith declare that the products:

Model name: SP-6600/6700, SP-7600/7700, SP-8600/8700 and
SP-8850/8950, SP-850

Model design: All versions

Technical data: Equipment group II, Category 2G and 3G
Marking: EX II 2G EX h IIB T4 Gb
Liquid temperature: Max. 40°C
Ambient temperature: +5°C to +40°C

Confirms with the relevant EC Directive: Directive 2014/34/EU for equipment and protective
systems intended for use in potentially explosive
atmospheres (ATEX).

Applied harmonized standards: EN ISO 80079-36:2016
EN ISO 80079-37:2016

In accordance with appendix VIII of 2014/34/EU the documents are stored by the notified body no.
2757, Intertek Italia S.P.A

Technical File no.: SPEX2022.01

The protection of the pump against abnormal working situations must be insured by user according to
the manual.

Signed,



Chris Murphy,
Director of Operations
June 2022



North America Declaration of Conformity

We here with declare that the construction type

Designation: **SP-280P**
 SP-280P-V
 SP-ENC
 SP-ENC-V

Machine type: Electric Motors for drum pumps

Item No: **SP-280P**
 SP-280P-V
 SP-ENC
 SP-ENC-V

In the form as delivered by us complies with following applicable regulations:

Conforms to UL STD 1004-1
Certified to CSA STD C22.2 No. 100
ETL Control number 5003012



Unibloc Hygienic Technologies.
Duluth, GA USA

Official responsible for documentation:
1 FEB 2016

Chris Murphy

Christopher Murphy
Director of Operations

EC Declaration of Conformity

We herewith declare that the construction type

Designation:	SP-280P-2	SP-280P-2-NL
	SP-280P-2-V	SP-280P-2-V-NL
	SP-ENC-2	SP-ENC-2-NL
	SP-ENC-2-V	SP-ENC-2-V-NL

Machine type: Electric Motors for drum pumps

Item No:	SP-280P-2	SP-280P-2-NL
	SP-280P-2-V	SP-280P-2-V-NL
	SP-ENC-2	SP-ENC-2-NL
	SP-ENC-2-V	SP-ENC-2-V-NL

In the form as delivered by us complies with following applicable regulations:

Machine Safety	2006/42/EC
Low Voltage Equipment	2014/35/EU
Electromagnetic Compatibility	2014/30/EU
RoHS Directive	2011/65/EU

Applied Harmonized Standards:

EN ISO 12100-1, -2	EN 60204-1
--------------------	------------

EC official responsible for documentation:

24 AUG 2015

Date

Unibloc Hygienic Technologies.
Duluth, GA USA



Christopher Murphy
Director of Operations

WARRANTY

Three year limited warranty

Standard Pump, Inc. warrants, subject to the conditions below, through either Standard Pump, Inc., its subsidiaries, or its authorized distributors, to repair or replace free of charge, including labor, any part of this equipment which fails within **three years** of delivery of the product to the end user. Such failure must have occurred because of defect in material or workmanship and not as a result of operation of the equipment other than in accordance with the instructions given in this material. Specific exceptions include:

- Consumable items such as motor brushes, bearings, couplings and impellers. (Motor brushes typically have a life span of approximately 250 hours. This will vary with the manner in which the motor is used)

Conditions of exceptions include:

- Equipment must be returned by prepaid carriage to Standard Pump, Inc., its subsidiary or authorized distributor.
- All repairs, modifications must have been made by or with express written permission by Standard Pump, Inc., its subsidiary or authorized distributor.
- Equipment which have been abused, misused, or subject to malicious or accidental damage or electrical surge are excluded.

Warranties purporting to be on behalf of Standard Pump, Inc. made by any person, including representatives of Standard Pump, Inc, its subsidiaries, or its distributors, which do not fall within the terms of this warranty shall not be binding upon Standard Pump, Inc. unless expressly approved in writing by a Director or Manager of Standard Pump, Inc. Information for returning pumps Equipment which has been contaminated with, or exposed to, bodily fluids, toxic chemicals or any other substance hazardous to health must be decontaminated before it is returned to Standard Pump, Inc, or its distributor. A returned goods authorization number (RGA #) issued by Standard Pump, Inc., its subsidiary or authorized distributor, must be included with the returned equipment. The RGA # is required if the equipment has been used. If the equipment has been used, the fluids that have been in contact with the pump and the cleaning procedure must be specified along with a statement that the equipment has been decontaminated.

Unibloc Hygienic Technologies US, LLC

1650 Airport Rd, Ste 110 • Kennesaw, GA 30144 • USA
Phone 770-218-8900 • E-Mail info.na@unibloctech.com

STANDARD PUMP EUROPE A/S

Ronnekrogen 2, DK-3400 Hillerod, Denmark
Phone +45 70 23 21 00 • Fax +45 70 23 56 55
info@standard-europe.eu